

# A Glimpse of SmartHG Project Test-bed and Communication Infrastructure

V. Alimguzhin, F. Mari, I. Melatti,  
and E. Tronci  
Computer Science Department  
Sapienza University of Rome, Italy  
{alimguzhin,mari,melatti,  
tronci}@di.uniroma1.it

E. Ebeid, S. A. Mikkelsen,  
and R. H. Jacobsen  
Department of Engineering  
Aarhus University, Denmark  
{esme, smik, rhj}@eng.au.dk

J. K. Gruber, B. Hayes,  
F. Huerta, and M. Prodanovic  
Instituto IMDEA Energía, Spain  
{jorn.gruber,barry.hayes,  
francisco.huerta,milan.  
prodanovic}@imdea.org

**Abstract**—The SmartHG project goal is to develop a suite of *integrated software services* (the *SmartHG Platform*) aiming at steering residential users energy demand in order to: keep operating conditions of the electrical grid within given healthy bounds, minimize energy costs, and minimize CO<sub>2</sub> emissions. This is achieved by exploiting knowledge (*demand awareness*) of electrical energy *prosumption* of residential users as gained from SmartHG sensing and communication infrastructure. This paper describes such an infrastructure along with user demand patterns emerging from the data gathered from ~600 sensors installed in ~40 homes participating in SmartHG test-beds.

## I. INTRODUCTION

Generation of electrical energy from renewables (e.g., from solar or wind energy) is both an opportunity and a challenge. It is an *opportunity* since renewables provide a potential infinite source of clean energy at an economically interesting price. It is a *challenge* since production of such an energy cannot be directly controlled because it depends on weather conditions.

To pursue such an opportunity, *smart* energy management approaches are needed in order to minimize mismatch between energy production and demand on one side and to keep electrical grid operating conditions within healthy bounds (e.g., to reduce wearing of transformers) on the other side. Devising approaches to address the above, possibly conflicting, requirements is at the very heart of *smart grid* research activity.

The SmartHG project addresses both such challenges by developing a suite of *integrated software services* (the *SmartHG Platform*) aiming at steering residential users energy demand in order to: keep operating conditions of the electrical grid within given healthy bounds, minimize energy costs, and minimize CO<sub>2</sub> emissions. This is achieved by exploiting knowledge (*demand awareness*) of habits (as for electrical energy production/consumption) of residential users as gained from SmartHG sensing and communication infrastructure. The control policies forming the backbone of such services have been described for example in [1]. Accordingly, this paper focuses on: 1) describing SmartHG sensing and communication infrastructure enabling *demand awareness* and on 2) outlining the user behaviors emerging from the data gathered from ~600 sensors installed in ~40 homes participating in the SmartHG test-beds.

The paper is organized as follows. Section III provides an overview of the SmartHG platform. Section IV provides an

overview of the SmartHG communication infrastructure. Section V describes SmartHG experiments with actuation carried out at the Microgrid available at the Instituto IMDEA Energía (IMDEA) Lab. Section VI describes Svebølle (Denmark) and Central District Region (Israel) test-beds as well as the data gathered from them. Section VII provides concluding remarks and outlines future research directions.

## II. RELATED WORK

SmartHG integrated software services rely on formal methods for verification and control synthesis from system level formal specifications, and have been previously presented in [1].

For several decades, network operators have used various forms of Demand Side Management (DSM) to reduce peaks loads and to improve the balancing of system supply and demand. The majority of the DSM programmes implemented worldwide to date have focused on large industrial consumers, since these have loads large enough to produce significant effects at the system level [2], [3]. However, a significant amount of recent research has focused much more on the possibilities for demand side participation from much smaller consumers, including residential users, e.g. [4], [5], [6]. The introduction of smart metering and Time of Usage (ToU) electricity pricing in many countries is creating new opportunities for individual users in the residential domain to participate in the electricity market, and to offer DSM as a service to the power system [7], [1]. Many existing DSM programmes use direct load control, where the network operator is able to directly actuate loads according to the needs of the network (e.g. [8], [9]). While direct load control may be suitable for certain industrial users, it has technical and practical difficulties in the context of residential users, where it is considered to be very invasive. Most residential DSM schemes instead rely on the user response to a electricity price signal to produce the required outcome [5], [6], [7], [1]. Recent studies carried out in Ireland [10] and in Denmark [11], have tested the response of residential users to various ToU electricity pricing schemes, in order to quantify their potential to offer DSM services. In order to achieve the volumes of demand required to participate in the electricity market, and to make a significant contribution to system-level energy balancing, a means of combining and coordinating DSM actions from many highly-distributed users is required. Several approaches for this have

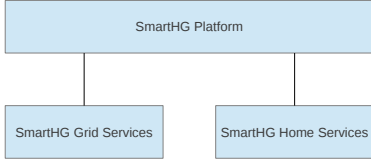

Fig. 1: The SmartHG Platform and its main Services

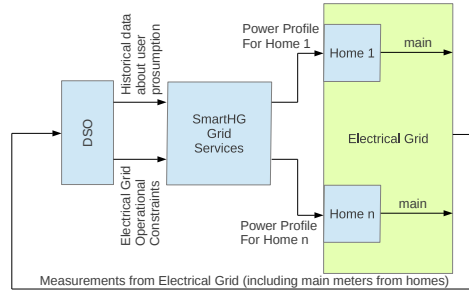

Fig. 2: SmartHG Services for Grid Operators

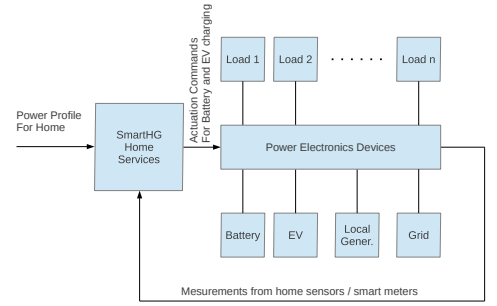

Fig. 3: SmartHG Services for Residential Users

been proposed, such as the “aggregator” [12] and “virtual power plant” concepts [13], [14].

In [15] the authors made a survey on the communication and information technologies of the smart grid. They presented the communication requirements, potential applications, and the smart grid roadmap that are considered the key to smart grid development process. Regarding SmartHG project, in [16] the Intelligent Automation Services (IASs) infrastructure and the exploited communication technologies in the project are presented. They chose the Representational State Transfer (REST) style architecture for the project’s infrastructure due to its simplicity and openness. Moreover, the authors have adopted ZigBee IP and Smart Energy Profile 2.0 standards due to their compliance with the Internet Protocol suite and state-of-the art web services development. In the same context, in [17] the authors presented a smart grid ICT architecture for SmartHouse/SmartGrid project. The project’s architecture is based on the interaction between smart houses and smart grids. They highlights the expected impacts of the architecture in terms of energy efficiency and efficient management of local power grids.

### III. THE SMARTHG PROJECT

In this section, we provide a brief overview of the SmartHG platform. The aim of such a description is to clarify how *demand awareness* from the field data is achieved and exploited for *smart energy management*.

The *SmartHG Platform* (Fig. 1) consists of a set of integrated *software services* supporting management of the Electric Distribution Network (EDN) (*SmartHG Grid Services*) as well as of the home devices (*SmartHG Home Services*) along with a communication infrastructure enabling reliable and secure communication among such services. SmartHG approach consists of a two-tier hierarchical control schema. At the top tier, the Distribution System Operator (DSO) sets operational constraints for the EDN and gets from the SmartHG Platform (Grid Services) a *power profile* (i.e., power constraints) for each residential user. At the bottom tier, the SmartHG Platform (Home Services) monitors and control home devices in order to keep at each time the home power demand within its power profile. In the following, we provide more details about the services in the SmartHG Platform.

#### A. SmartHG Grid Services

The SmartHG platform supports the top tier control loop with its *SmartHG grid services* whose role is that of supporting

the DSO in keeping hardware devices in the EDN, in particular transformers, within its operational bounds. This depends on the energy demand. Accordingly, the SmartHG platform tries to steer energy demand from residential users so that the resulting *aggregated demand* (i.e., the sum of the electrical demand from all residential users considered) drives EDN devices in such a way that EDN operational constraints are met.

The SmartHG platform achieves such a result as illustrated in Fig. 2. First, for each substation to be controlled by the SmartHG platform, the DSO provides (to the SmartHG platform) operational constraints for such a substation along with historical data about energy consumption/production for each user connected to it. Second, from such data the SmartHG platform (Grid Services) computes, for each user, a *power profile*, that is time functions defining, respectively, at any time in the next day, the maximum and minimum power demand allowed for that user. Such a computation is *demand-aware*, that is, the computed power profiles are such that for each user it is *easy enough* to meet them. In other words, the power profiles proposed by the SmartHG platform are such that each user *almost* meets them without taking any action. More details about how such a computation is carried out can be found in [1].

#### B. SmartHG Home Services

The SmartHG platform supports the bottom tier control loop with its *SmartHG home services* whose role is that of supporting each residential user in meeting the power profile proposed by the DSO (and computed by the SmartHG Grid Services in our setting). This is summarised in Fig. 3.

The SmartHG platform is fully automatic from a residential user perspective. That is, no involvement is expected from the user. Demand steering is achieved by controlling energy storage devices, namely batteries installed to support SmartHG as well as batteries from Plug-in Electric Vehicle (PEV). The SmartHG home services control charge and discharge of home batteries in such a way that the home power demand to the EDN meets the power constraints provided by the DSO for that home. Of course effective planning of battery usage requires forecasting of future energy needs for the home. Accordingly, SmartHG home services also provide home energy usage forecasting capabilities. In order to control home energy storage devices, SmartHG home services measure the home main meter, status of the batteries, local generation (if any), and energy consumption from home appliances (to improve

forecasting quality). Note that no data about home usage of appliances need to be sent outside the home in our two-tier approach. Indeed, once the power constraints from the DSO are received, SmartHG home services can work even without Internet connection (power constraints will not be updated then) making them, as a matter of fact, an *autonomous system*.

Experimentation with energy storage devices cannot be done at the home premises. Accordingly, we use a Micro grid to experiment with actuation. To this end, we have a dedicated test facility at IMDEA Smart Energy Integration Lab (SEIL) where we drive Micro grid loads using sensor data from SmartHG home test-beds and we drive Microgrid batteries using data from PEV usage (recorded from the Danish project Test-an-EV) and SmartHG services. This allows us to carry out experiments with actuation much as if we were in one of the homes in our test-beds equipped with a PEV and a battery.

### C. SmartHG Platform Infrastructure

In order to make the above outlined architecture work, we need a communication infrastructure enabling communication between SmartHG Services and hardware devices. This allows us to perform a data gathering campaign, which is the basis for the design of effective SmartHG services. In this paper we first describe SmartHG communication infrastructure (Section IV), then describe the Micro grid we used to experiment with battery control (Section V) and finally (Section VI) we describe SmartHG test-beds where we gathered data about energy demand from residential users and present some data analytics.

## IV. SMARTHG COMMUNICATION INFRASTRUCTURE

This section presents the main project’s communications infrastructure. It shows the interactions between the home devices, Database and Analytics (DB&A), and DSO. Fig. 4 shows the main building blocks of such infrastructure. Home Area Network (HAN) transmits\receives metering\actuating data of the home devices to\from the cloud services via Internet connection. The project’s IASs and the DSO access such data and analyze it. More details about the communication infrastructure technologies are in [16].

Fig. 5 shows a detailed deployment of the project’s main devices and its services. It shows how the interactions between the services and the devices are occurring and which communication technologies are using. For instance, a washing machine sends its power consumption measurements to the home’s ZigBee gateway. A Raspberry Pi based kit called Home Energy Controlling Hub (HECH) allows the gateway to communicate with the database via an internal server called SmartAMM (*Smart Advanced Management Module*). The server is developed by the project’s partner Develco Products (DEVELCO) and it uses back-end tools to handle the received\transmitted data. In this project, we have developed a back-end to filter only the desired data and post them to the DB&A. Services such as Energy Bill Reduction (EBR) sends actuating commands to the home devices (e.g., batteries) via the SmartAMM server.

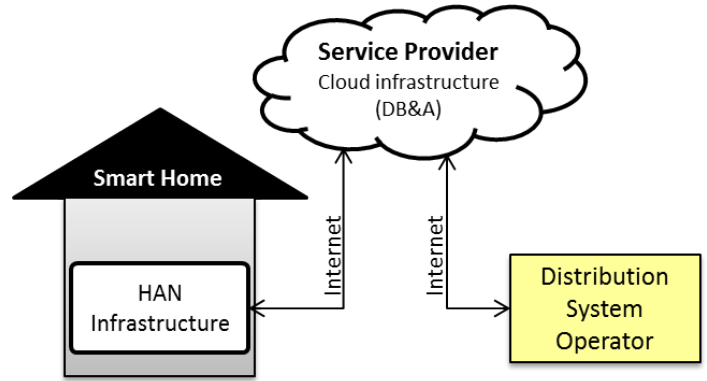

Fig. 4: Communication infrastructure concept

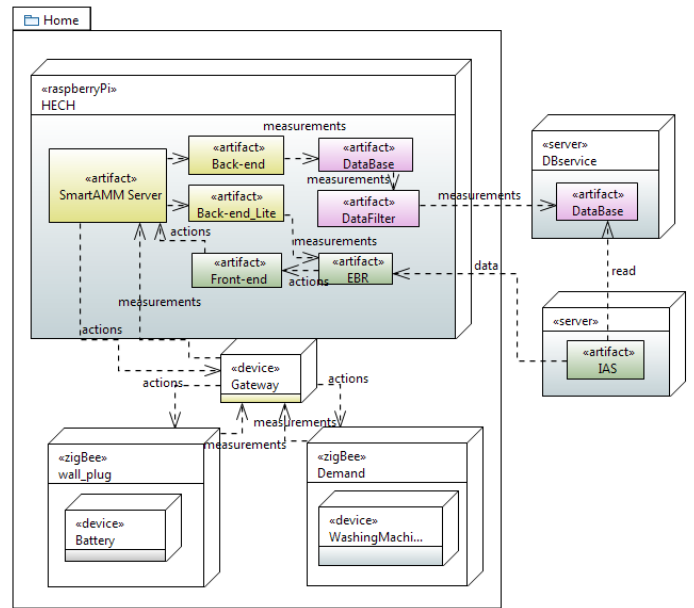

Fig. 5: Deployment diagram of the communication infrastructure

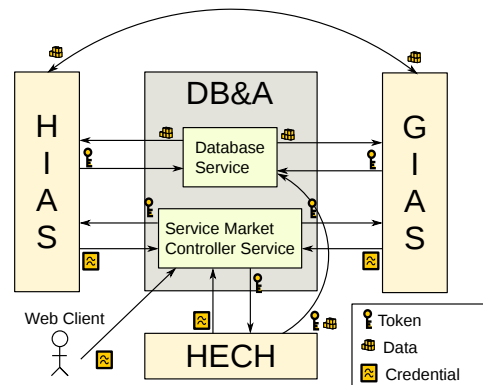

Fig. 6: High-level representation of the communication paths for the access control and the data dissemination for the DB&A service

## A. Home Area Network

It is a dedicated network connecting home devices. In SmartHG project, HAN devices are communicating with the IASs via DEVELCO home automation middleware called SmartAMM server. The SmartAMM Communication System consists of two core components: the Communication Service Provider (CSP) and the SmartAMM API (API). The CSP is handling the communication with the remote SmartAMM gateways, and the API library is used by both the CSP and optionally systems wishing to utilize the CSP. In the project, we have customized an API of the server's backend to handle the metering home devices telegrams and post them to the DB&A.

## B. Database and Analytics

Metering data represent the main asset for the stakeholders in a smart grid, and therefore it is crucial for the communication infrastructure how this is handled. In the SmartHG ecosystem, the DB&A are responsible for storing and disseminating metering data, while ensuring authentication and access control. The DB&A is divided into two Representational State Transfer (RESTful) web services: a Service Market Controller (SMC) web service that is aware of service locations and verifies the authentication and authorization; a database service that provide analytic views of the metering data.

The division allows the SMC service to act as a proxy for accessing services, and thereby making the all other services exchangeable. Furthermore, it allows existing commercial partners in the energy metering sector to interchange data with database service. Data obtained from proprietary solutions can be reused in the ecosystem, thus facilitating integration without breaking any proprietary constraints.

Fig. 6 illustrates the interconnection between the HECH, Home Intelligent Automation Service (HIAS) and Grid Intelligent Automation Service (GIAS). The HECH is preregistered with a shared secret and the location of SMC service. It retrieves information about the location of the database service and gets a token, allowing it to post to the database service. Meta information (e.g., association between a sub meter and an appliance) and metering data from the residential houses are posted to the database service through the RESTful API. The HIAS and GIAS are able to request access either directly to the raw metering data or by requesting analytic representations, e.g., consumption aggregation on substation level using the same token system as the HECH. Similarly, the HIAS and GIAS can exchange data from each other through the SMC service's authorization system.

1) *Service Market Controller*: The SMC is an authentication and authorization server for three stakeholders of the system; the HECH that supplies the metering data to other services, the services that want to access each others' data, and the web clients accessing the services directly as seen in Fig. 6. It is based on the OAuth 2.0 (OAuth2) authorization framework [18] with a shared authentication scheme built on top. The authorization process between the client and resource service are carried over an established HTTPS connection with HTTP redirects. This increase both interoperability and horizontal scale by being RESTful compliant. The OAuth2 scheme only assumes the clients follow the HTTP protocol,

thus facilitating both web browser clients and service clients to operate equally without extending it with additional client support. Access delegation to the database service is based on self-contained tokens that are exchanged when the authenticity of the requesting client is verified by SMC service. The tokens define the scope of access and are time-limited. Expired tokens can be refreshed automatically within an expiration time set by its owner.

2) *Database Service*: The database service is an exchangeable self-contained RESTful web service. It supports the operations and added value for the HIAS and GIAS by providing common analytic views of the measurement data; this includes: Aggregation views (e.g., weekly, monthly and yearly) of the consumption and production data on residential house level with a given time interval and granularity; Data quality indicator on residential house level given a tolerance time span that detects missing data within a given time interval; Interval filtering for time and value on meter port level; Generation of condensed datasets on appliance level with a fixed sampling period. The views are provided as REST representations on URI endpoints (e.g., [https://dbservice.org/energy\\_consumption/](https://dbservice.org/energy_consumption/)), while the filtering capabilities are set through URI query parameters (e.g., <https://dbservice.org/?key1=value1&key2=value2>).

3) *Implementation*: Both the SMC service and database service are implemented as Python-based web applications in the Django Web Framework and REST toolkit. The Python language allows for integration with existing open source web applications, and thereby shrinks development time, but it comes with a performance penalty. The slow performance is compensated by using Gunicorn as web server for hosting the web application and Nginx as a reverse proxy for delegating the burden of processing the SSL/TLS encryption in HTTPS and delivering the static content. Nevertheless, processing the analytic views can be time consuming, thus for avoiding processing on-request, the database service have a background caching system that independently process the common views before being requested.

## C. Distribution System Operator

The DSO interact with IAS through the DB&A service using the RESTful APIs provided by the service. A customization of the Common Information Model (CIM) is used to ensure interoperability between IASs. The CIM is an open standard for representing power system components and networks and has been documented in the IEC 61970 series and the IEC 61968 series. The SmartHG infrastructure utilizes CIM to provide a data exchange format for service provisioning hereby bridges the gap between the SmartHG infrastructure and the ICT systems of the DSO.

## V. SMART ENERGY INTEGRATION LAB

The Smart Energy Integration Lab (SEIL)[19], where we carried out some demonstration experiments, was conceived by the Electrical System Unit at IMDEA as a flexible facility that uses PHIL technology to obtain realistic experimental results. The laboratory is designed for studying electricity networks, including microgrid control and management strategies, emulation of scenarios for renewable energy grid integration

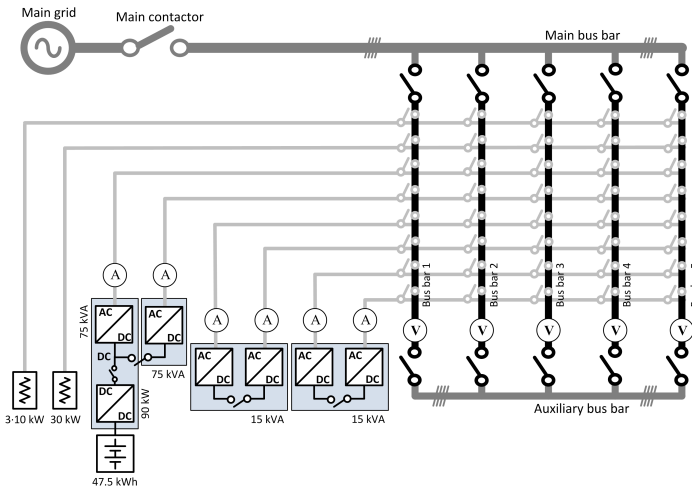

Fig. 7: Description of Smart Energy Integration Lab at IMDEA

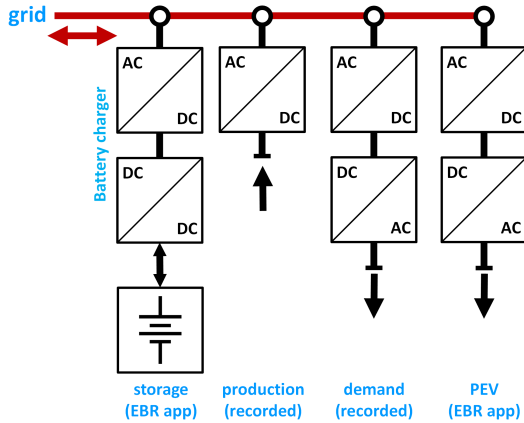

Fig. 8: Smart Energy Integration Lab configuration

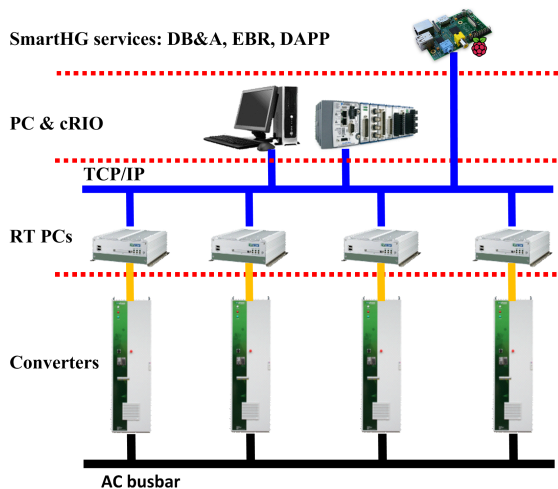

Fig. 9: Controlling Smart Energy Integration Lab

and verification of power dispatch algorithms. The SEIL is formed by a set of power electronic converters, resistive loadbanks, a battery system, distribution panels and monitoring and control systems. This platform allows analysis, development and testing of realistic scenarios for energy integration in both AC and DC networks and also operation of distribution power networks, islanded networks and microgrids. The results obtained from this test environment are more reliable and accurate than any results coming from model based computer simulation. What distinguishes this laboratory is its flexibility in implementation of control algorithms and simple access to all test and management data from any part of the network. The SEIL is capable of recreating a large number of different events that occur in real power networks and, therefore, represents a useful tool when it comes to research, development and implementation of energy management algorithms.

The SEIL consists of (see Fig. 7): 4 x 15 kVA three-phase power converters; 2 x 75 kVA three-phase power converters; 4 industrial PCs with RT operating systems; 2 x 30 kW balanced and unbalanced, programmable resistive loadbanks; 47.5 kWh Li-Ion battery system with BMS; 90 kW bidirectional battery charger; configurable three-phase AC matrix busbar system; independent monitoring and control system based on cRIO technology of National Instruments. Control algorithms for power converters are programmed via Matlab-Simulink and code generation tools and then executed in real-time on industrial PCs. Real-time data exchange provides access to all control variables and parameters during the test. In this way the desired flexibility in reproducing real dynamic characteristics of any energy source, generator or load is achieved.

The setting for home simulation in SEIL consists of four elements: the Photovoltaic (PV) generation, the aggregated home demand, a battery system and a PEV. The different elements are emulated by using the components of SEIL as is shown in Fig. 8: the 47.5 kWh battery and the charger are used as the home battery system, two 15 kVA converters are configured as an active load and used to simulate the aggregated home demand, a 75 kVA converter is used to emulate the PV generation and two 15 kVA converters are also configured as an active load emulate the PEV. Fig. 9 outlines the interaction with the SEIL control systems from SmartHG HIAS. The PC and the cRIO control system are used as a bridge between the SmartHG HIAS and the RT computers. They send the command references to the RT computers to effectively control the converters and in turn they receive readings about the system power flows and the state-of-charge. In addition to that, the RT computers send the information back to the SmartHG HIAS that is used then to calculate the battery and the PEV power commands. In order to reproduce the previously collected PV and demand power profiles from the Svebølle test-bed.

## VI. SMARTHG TEST-BEDS

In this section we describe the two SmartHG test-beds, which have been set up in Svebølle (Kalundborg, Denmark) and Central District (Israel). The SmartHG test-beds have been set up to gather field data in order to enable evaluation of the services developed inside SmartHG.





Fig. 10: DEVELCO smart plugs



Fig. 11: PANPOW sensors



Fig. 12: Sensors deployed in Svebølle

### A. Svebølle (Denmark) Test-Bed

Svebølle is a village with approximately 850 homes situated 14 km east of Kalundborg city in Denmark. A district in Svebølle is identified as the main test area, because of its combination of houses with district heating, PV panels, and heat pumps. Furthermore, the age of the houses span from the late 1980s to now, which gives a range of buildings with different compliances to energy savings.

Sensors, smart meters and communication devices have been deployed in 25 houses in Svebølle (see Fig. 12 for an example of installed sensors), by SEAS-NVE qualified electricians, who will take also in charge the maintenance of installed devices. All houses in the Svebølle test-bed have sensors measuring instantaneous values for voltage and current at the main meter as well as sensors measuring inside temperatures and energy consumption for relevant appliances such as heat pump, electric oven, laundry machine, dishwasher, etc. See Fig. 13 for an example of deployment in Svebølle. The sensors and the smart meters available in *all* houses participating in the Svebølle test-bed will allow us to measure all uncontrollable inputs (e.g., energy consumption as well as energy production from PV panels, if any) for all houses in the test-bed.

### B. Central District (Israel) Test-Bed

The Central District is one of the six administrative districts of Israel. Sensors and communication devices have been deployed in 19 houses in Central District to monitor the main circuits to the houses: the air conditioning (used for heating as well), the boiler (domestic water heating), and where present, the pool pump. These are the main electric consumers in the Central District home, given Israeli warm climate. Three of the homes also show electric car charging spots.

### C. Deployed Hardware Devices

In this section we describe the devices that have been deployed in SmartHG test-beds. Table I summarises the present hardware deployment on SmartHG test-beds.

Test-bed	Monitored houses: appliances and main	Hardware deployed
Svebølle (Denmark)	25	247 clamp meters 25 bridges 59 smart meters 25 gateways 50 temperature sensors
Central District (Israel)	19	299 clamp meters 26 bridges

TABLE I: SmartHG test-beds deployment status

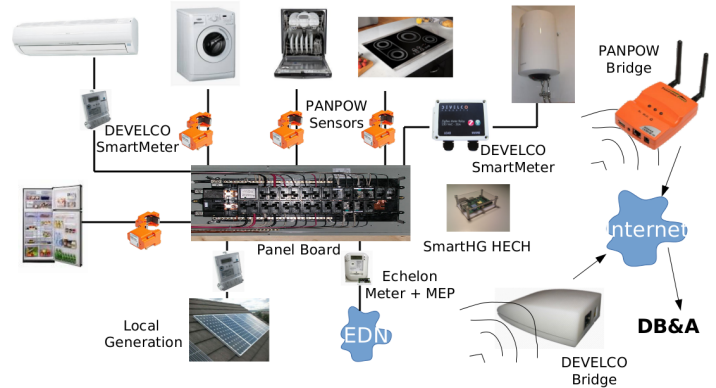

Fig. 13: Svebølle deployment example

1) *Smart Meters, Gateways and Temperature Sensors:* DEVELCO provided (see Fig. 10): smart plugs that can both act as meters and as relays (to sense and switch them on/off); gateways that will handle the wireless ZigBee network, control devices, collect data, and transmit data to the DB&A; user interface (battery driven device with two LEDs) for turning on/off all appliances at the same time; temperature sensors.

2) *Clamp Meters and Bridges:* PANPOW provided (see Fig. 11): clamp meters to monitor loads up to 63 Amperes, max cable diameter 7mm (PAN10); clamp meters to monitor loads up to 225 Amperes, max cable diameter 17mm (PAN12); bridges that deliver energy information from the clamp meters every 10 seconds.

3) *Home Energy Controlling Hub (HECH) kit:* Aarhus University provided Home Energy Controlling Hub (HECH) kits, composed by: Raspberry Pi board; DEVELCO Smart Meters (ZigBee devices and gateway, see Section VI-C1); USB stick; Internet cable; power supply.

All data gathered by sensors and smart meters deployed in the SmartHG test-beds are stored in the SmartHG DB&A. The PANPOW dashboard will be used by both the homeowners involved in SmartHG and the project partners to view the energy use of the individual homes monitored in the project pilot sites. Only users with private and secure username and password can log in to the PANPOW dashboard. PANPOW dashboard allows for several functionalities as, e.g., monitoring hourly, weekly, daily energy consumption for a single house, possibly divided in categories of sensed appliances.

### D. Data Analytics

In this section we show statistics and aggregations on data gathered from SmartHG test-beds. We start with statistics

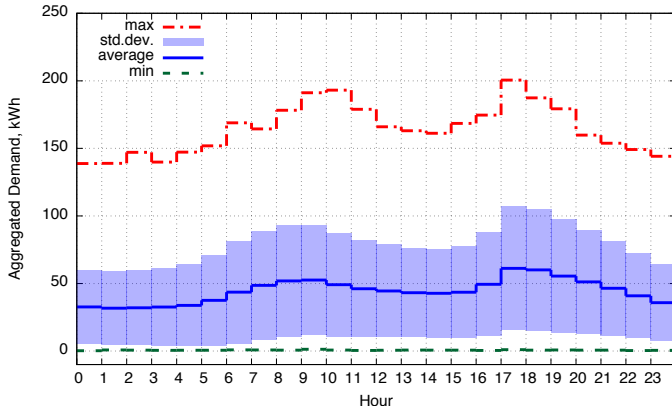

(a) Svebølle

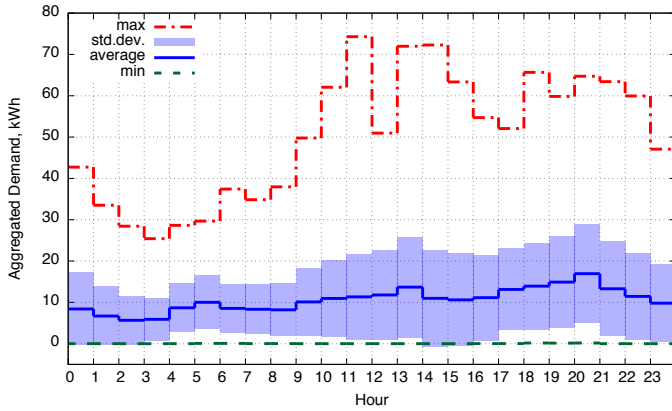

(b) Central District

Fig. 14: Statistics on one day for aggregated demand

on the aggregated demand in each one of the two test-beds, flowing down to the level of residential users demand.

Figs. 14a and 14b show how the aggregated demand of the two test-beds varies along the average day. Namely, for each time-slot  $t$  in a day, Figs. 14a and 14b show the average of the aggregated demand measured in time-slot  $t$  of all days in the measurement period. In particular, they show average ( $\pm$  standard deviation), minimum and maximum profiles. Note that in Fig. 14a values for aggregated demand are greater than the ones in Fig. 14b, since Svebølle test-bed contains more houses. Figs. 15a and 15b show how the average user demand varies along the measurement period. Namely, for each time-slot in the measurement period, Figs. 15a and 15b show the average of the users demand in time-slot  $t$ . In particular, they show average ( $\pm$  standard deviation), minimum and maximum profiles on all users of each test-bed. Note that the beginning part of Fig. 15b is flat (same values for max, min, and average). This is because deployment in Central District test-bed has undergone a longer initial installation phase than it was needed in Svebølle. Figs. 16a and 16c show users distribution as for average daily energy consumption in the whole period on the two test-beds, while Fig. 16b shows the same information computed per month, January, for Svebølle. Note how user distribution changes when considering the whole period against only one month. As an example, Fig. 16b representing a cold

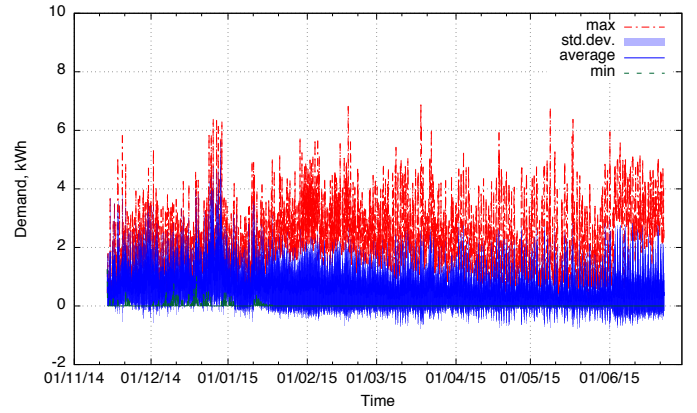

(a) Svebølle

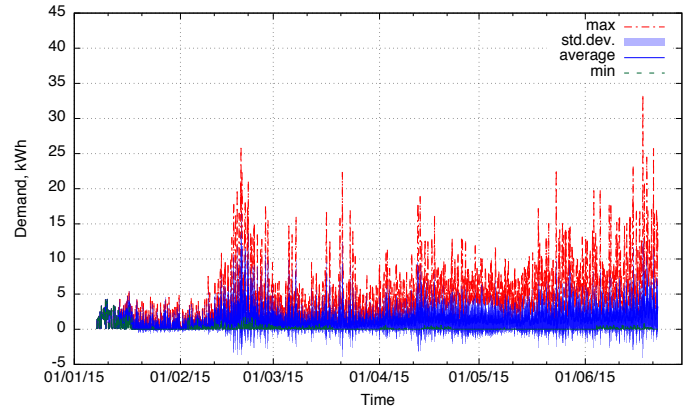

(b) Central District

Fig. 15: Statistics on the whole period for users

month has a range for average daily energy consumption which is wider than Fig. 16a. Figs. 17a and 17b show distribution of consumption among different kinds of appliances, for aggregated demands in the whole period. This is shown by using a pie graph where 100% corresponds to the overall consumption taken from the main meter. Note, as an example, that in Svebølle test-bed there is more consumption related to “Heating and Cooling” than in Central District one. Such plots also show the categories of appliances we are sensing. As an example, Fig. 17b shows category “Misc.” containing EV, pools, etc., “Machinery” sensing motors, pumps, etc.

## VII. CONCLUSIONS AND FUTURE WORK

The *SmartHG Platform* aims at steering residential users energy demand in order to: keep operating conditions of the electrical grid within given healthy bounds, minimize energy costs, minimize CO<sub>2</sub> emissions. This is achieved by exploiting knowledge (*demand awareness*) of electrical energy production/consumption of residential users as gained from SmartHG sensing and communication infrastructure. In this paper we described SmartHG sensing and communication infrastructure enabling demand awareness and outlined user demand analytics from the data gathered from the sensors installed in the homes participating in SmartHG test-beds. Investigation on how to use demand-awareness for distributed control of

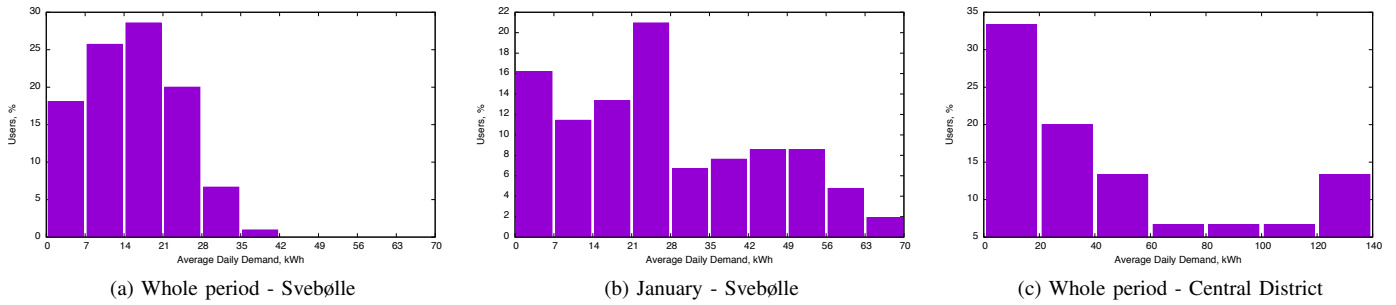

Fig. 16: Users distribution for average daily energy consumption

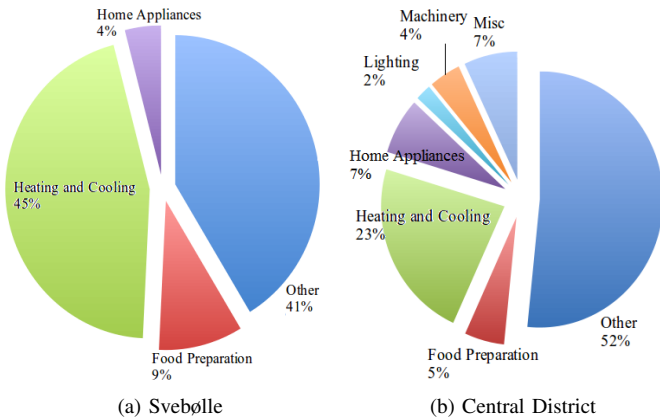

Fig. 17: Aggregated consumption distribution for kind of appliance

residential user demand appears a promising direction for further research.

#### ACKNOWLEDGMENTS

The authors wish to thank the following colleagues for their insights about the data gathered from the project testbeds: Francesco Davì, Toni Mancini and Ivano Salvo from Sapienza University of Rome (Italy); Lars Elmegaard from SEAS-NVE (Denmark); Dorthe Gårdbo-Pedersen and Peter Kirketerp Hansen from Develco Products (Denmark); Gev Decktor, Sharon Zimmerman and Adi Shamir from Panoramic Power (Israel).

The research leading to these results has received funding from the EU Seventh Framework Programme (FP7/2007-2013) under grant agreement N. 317761 (SmartHG).

#### REFERENCES

- [1] T. Mancini, F. Mari, I. Melatti, I. Salvo, E. Tronci, J. Gruber, B. Hayes, M. Prodanovic, and L. Elmegaard, "Demand-aware price policy synthesis and verification services for smart grids," in *IEEE SmartGridComm* 2014, pp. 794–799.
- [2] IEA DSM, "Assessment and development of network driven demand side management measures," <http://www.ieadsm.org/>, International Energy Agency, 2008.
- [3] B. Hayes, "Distributed generation and demand side management : Applications to transmission system operation," Ph.D. dissertation, The University of Edinburgh, 2013.
- [4] B. Hayes, I. Hernando-Gil, A. Collin, G. Harrison, and S. Djokic, "Optimal power flow for maximizing network benefits from demand-side management," *IEEE Trans. Power Syst.*, vol. 29, no. 4, pp. 1739–1747, 2014.
- [5] J. Torriti, "Price-based demand side management: Assessing the impacts of time-of-use tariffs on residential electricity demand and peak shifting in northern italy," *Energy*, vol. 44, no. 1, pp. 576 – 583, 2012.
- [6] P. Samadi, H. Mohsenian-Rad, V. Wong, and R. Schober, "Tackling the load uncertainty challenges for energy consumption scheduling in smart grid," *Smart Grid, IEEE Transactions on*, vol. 4, no. 2, 2013.
- [7] C. Adika and L. Wang, "Demand-side bidding strategy for residential energy management in a smart grid environment," *Smart Grid, IEEE Transactions on*, vol. 5, no. 4, pp. 1724–1733, July 2014.
- [8] Red Elctrica de Espaa. (2015) <http://www.ree.es/en/activities/operation-of-the-electricity-system/interruptibility-service>
- [9] National Grid. (2015) National grid balancing services. [Online]. Available: <http://www2.nationalgrid.com/uk/services/balancing-services/>
- [10] CER Smart Metering Project website. Irish Social Science Data Archive. [Online]. Available: <http://www.ucd.ie/issda/data/commissionforenergyregulationcer/>
- [11] Win with new electricity habits. SEAS-NVE project report. [Online]. Available: <http://ipaper.ipapercms.dk/SeasNVE/Winwithnewelectricityhabits/>
- [12] J. Medina, N. Muller, and I. Roytelman, "Demand response and distribution grid operations: Opportunities and challenges," *Smart Grid, IEEE Transactions on*, vol. 1, pp. 193–198, 2010.
- [13] D. Pudjianto, C. Ramsay, and G. Strbac, "Virtual power plant and system integration of distributed energy resources," *Renewable Power Generation, IET*, vol. 1, pp. 10–16, 2007.
- [14] N. Ruiz, I. Cobelo, and J. Oyarzabal, "A direct load control model for virtual power plant management," *IEEE Transactions on Power Systems*, vol. 24, pp. 959–966, 2009.
- [15] V. C. Gungor, D. Sahin, T. Kocak, S. Ergut, C. Buccella, C. Cecati, and G. P. Hancke, "A Survey on Smart Grid Potential Applications and Communication Requirements," *IEEE Transactions on Industrial Informatics*, vol. 9, no. 1, pp. 28–42, Feb. 2013.
- [16] R. H. Jacobsen and S. A. Mikkelsen, "Infrastructure for intelligent automation services in the smart grid," *Wireless Personal Communications*, vol. 76, no. 2, pp. 125–147, 2014.
- [17] K. Kok, S. Karnouskos, D. Nestle, and A. Dimeas, "Smart houses for a smart grid," *IET Conference Proceedings*, pp. 751–751(1), 2009.
- [18] D. Hardt, "The OAuth 2.0 Authorization Framework," RFC Editor, Tech. Rep., 2012.
- [19] F. Huerta, J. Gruber, M. Prodanovic, and P. Matatagui, "A power-hil microgrid testbed: Smart energy integration lab (seil)," in *IEEE ECCE* 2014, pp. 3998–4003.